



#13049-000

# Exhaust lift



The exhaust lift is intended exclusively for off-road sports.

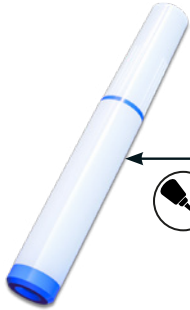

## Legend



Assembly Tip



Screw



Caution



Screw lock



Enlargement



Torque



Assembly paste



Cleaner

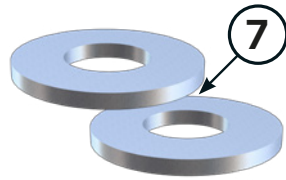

#	Component		Quantity
1	Exhaust lift		1
2	Exhaust clamp		1
3	Exhaust bracket		1
4	Cylinder head screw	M8×60	2
5	Washer	M8	2
6	Sleeve	12mm	2
7	Washer	M5	2
8	Screw lock		1
9	Ceramic paste		1

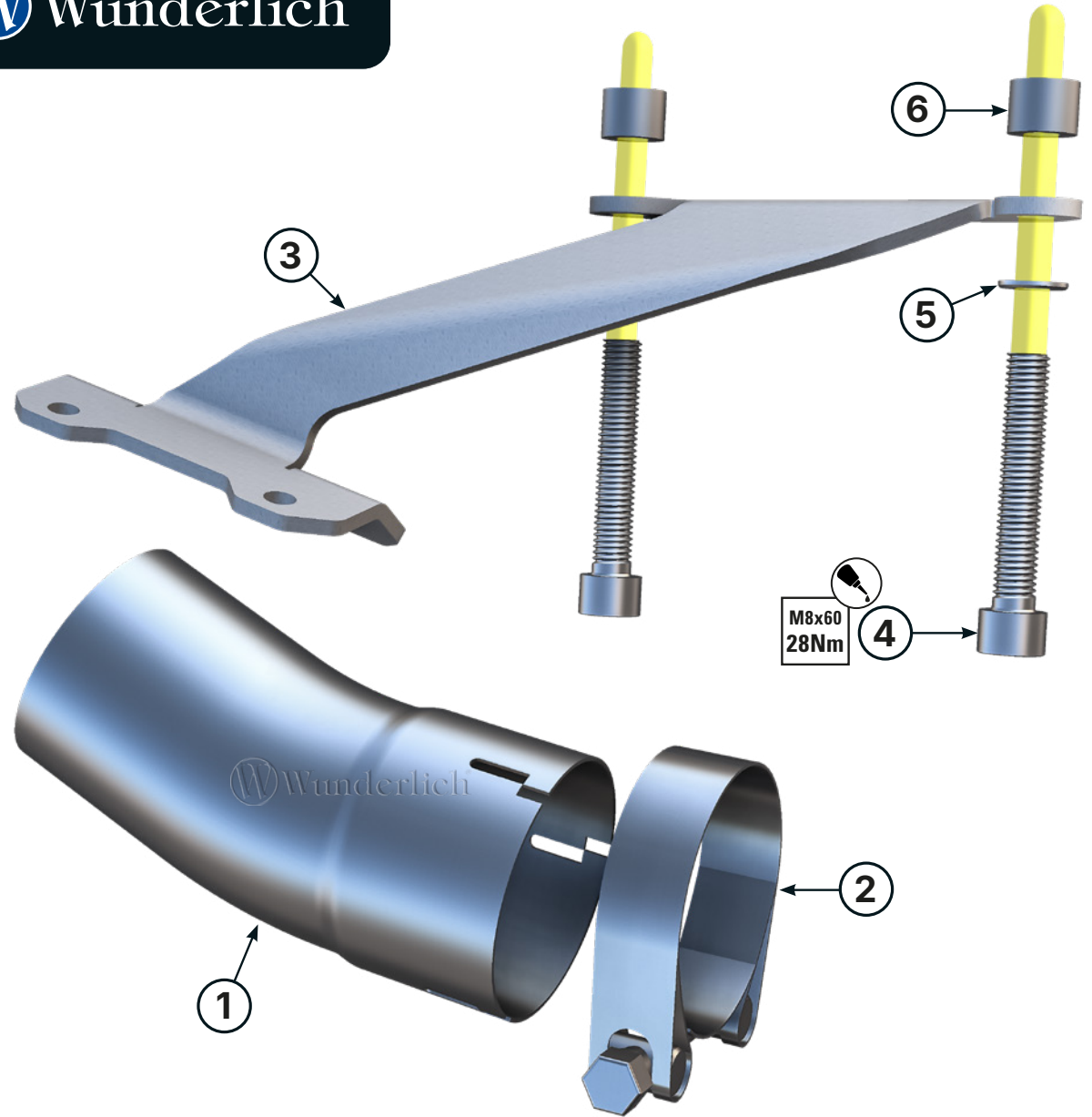

Pre-assemble all components loosely on the vehicle and align them. Only then tighten the screws as specified.

12.02.2026

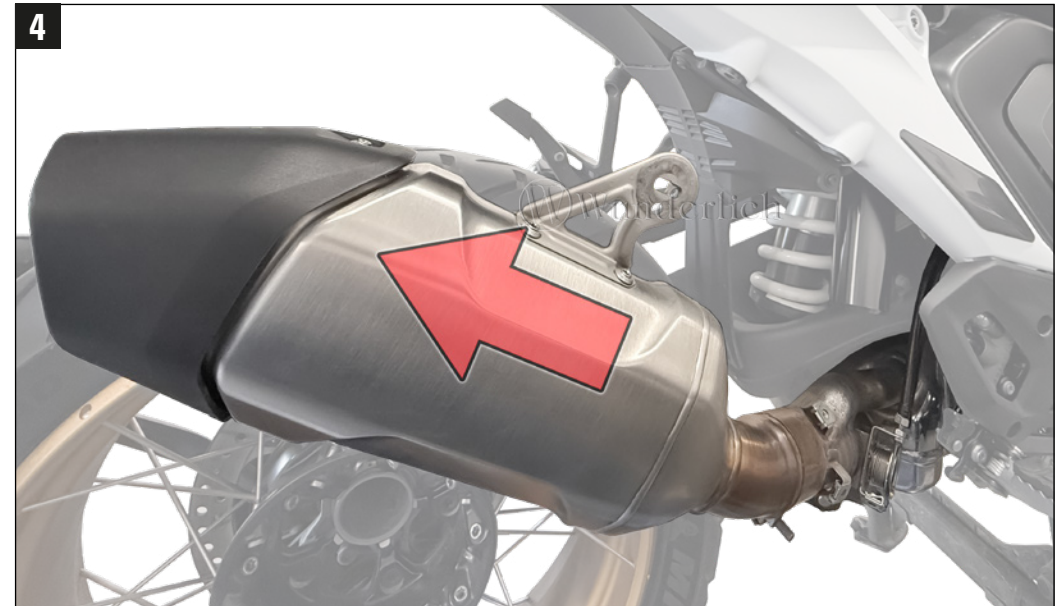
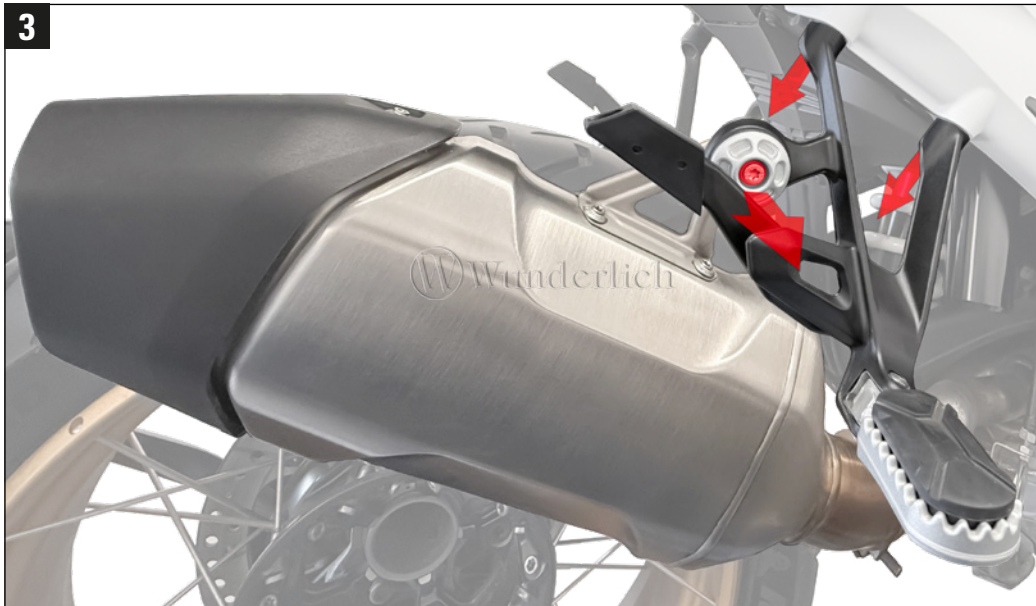
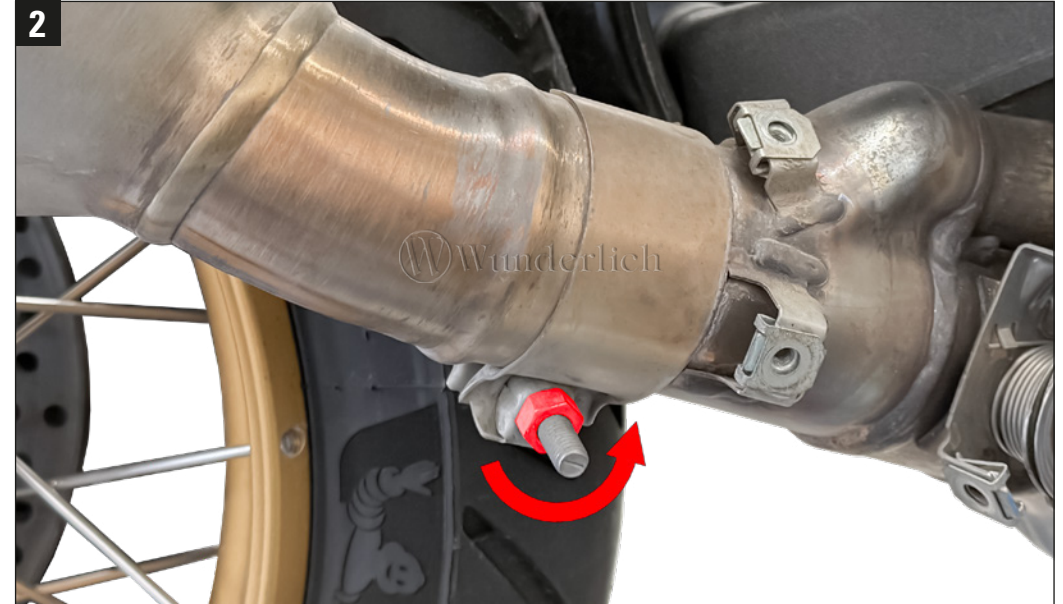

5

The original screws will be reused!



6

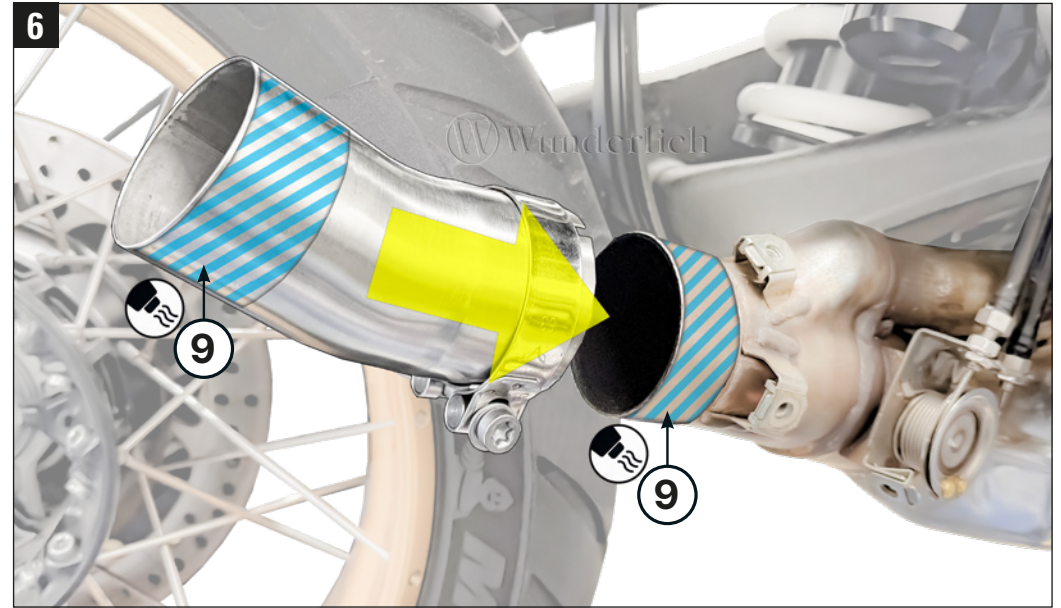

7

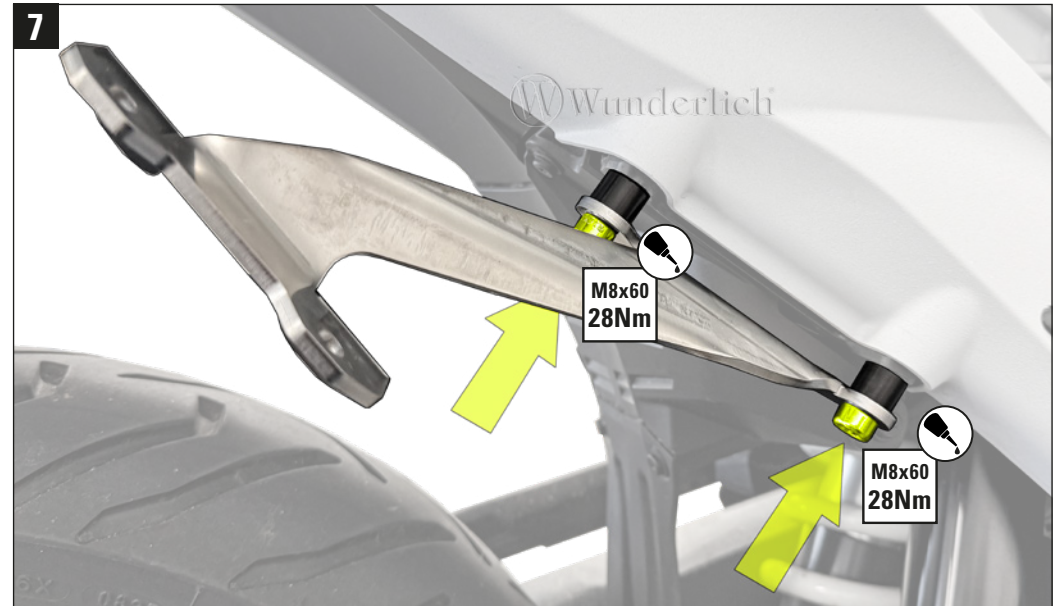

8

The original screws will be reused!

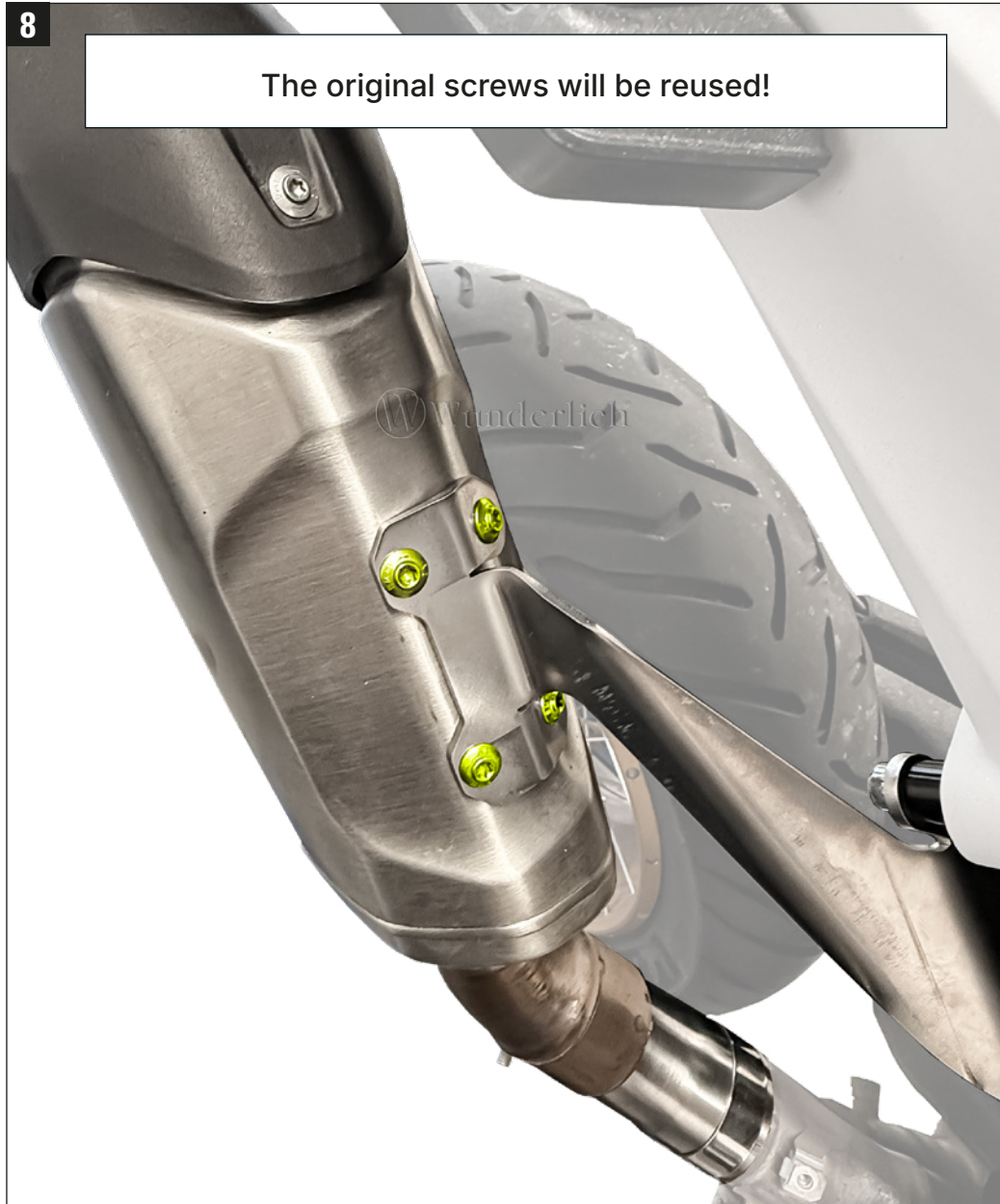

9



Use the washers No. 7 at the illustrated position.

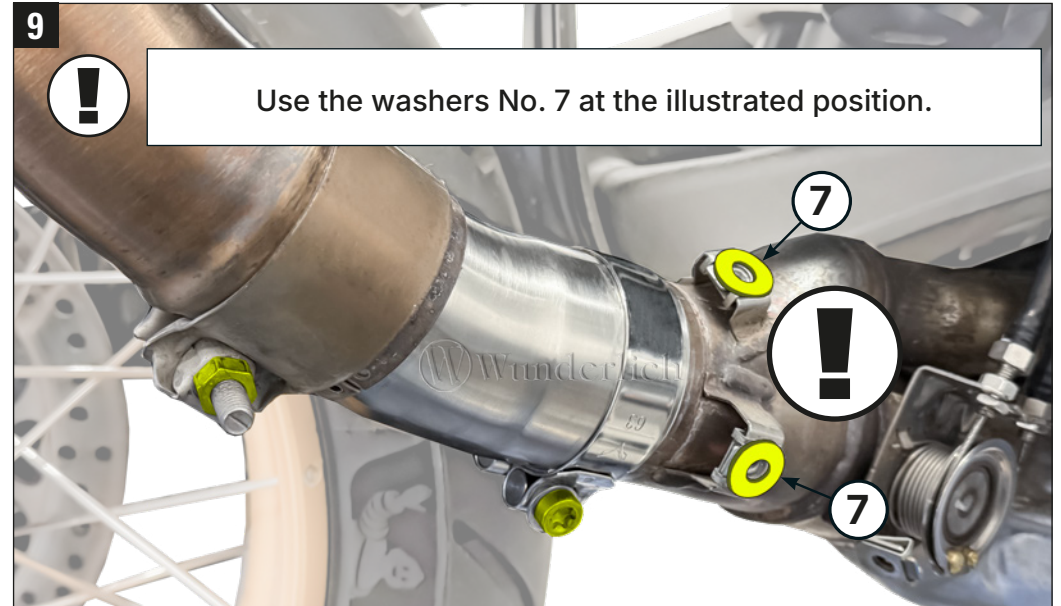

10

The original screws will be reused!

