

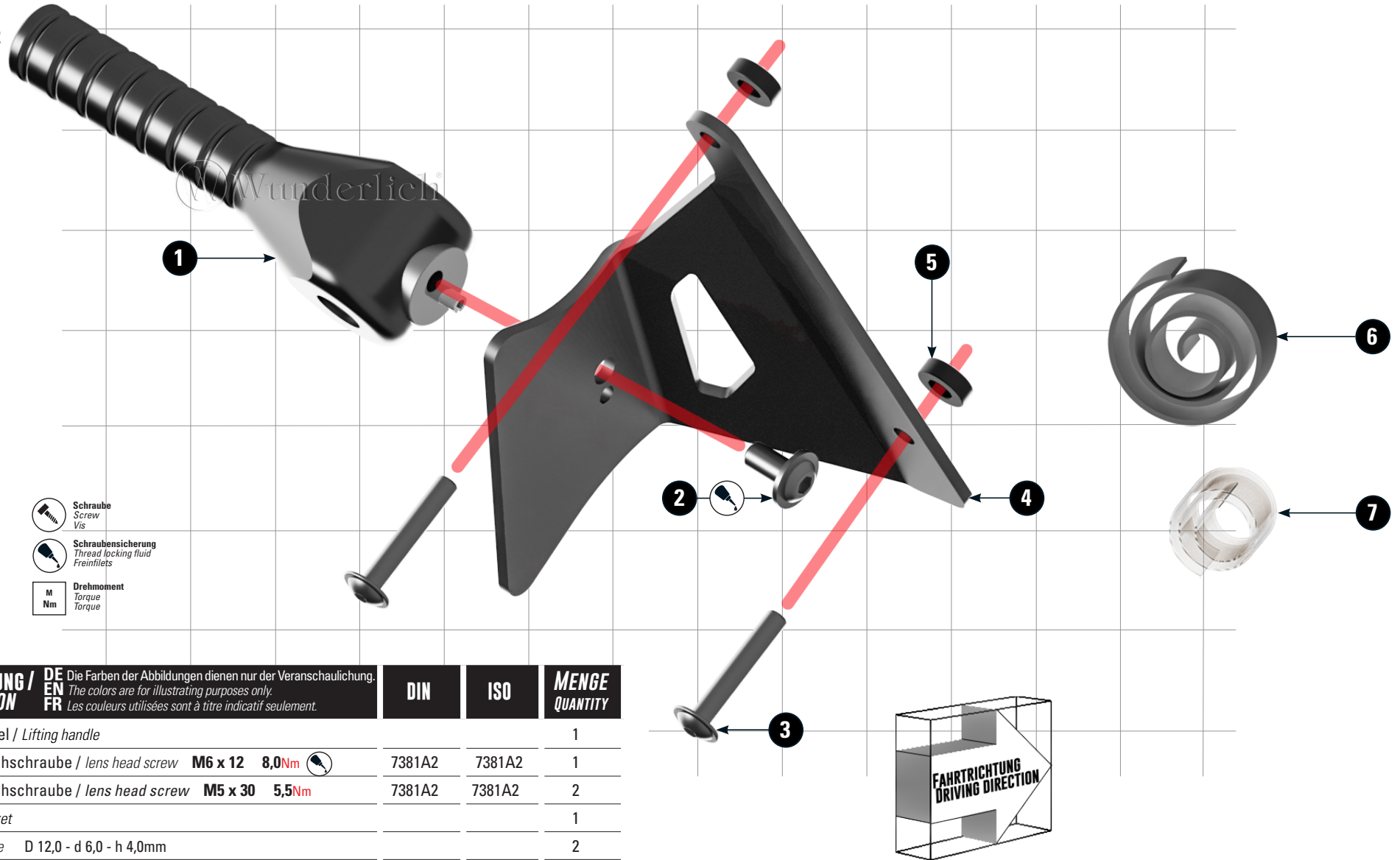



# AUFBOCKHEBEL KLAPPBAR



Lifting handle foldable | Palanca plegable de elevación | Levier de cric repliable | Maniglia di sollevamento ribaltabile

Art.-Nr: 26201-002



## LEGENDE/KEY/FILE LÉGENDE

-  **Anbau Tipp**  
Fitting tip  
Astuce de montage
-  **Achtung**  
Attention  
Attention
-  **Vergrößerung**  
Magnification  
Grossissement
-  **Montagepaste**  
Fitting lubricant  
Lubrifiant de montage

-  **Schraube**  
Screw  
Vis
-  **Schraubensicherung**  
Thread locking fluid  
Freiniflets
-  **Drehmoment**  
Torque  
Torque

#	BEZEICHNUNG / DESCRIPTION	DE EN FR	Die Farben der Abbildungen dienen nur der Veranschaulichung. The colors are for illustrating purposes only. Les couleurs utilisées sont à titre indicatif seulement.	DIN	ISO	MENGE QUANTITY
1	Aufbockhebel / Lifting handle					1
2	Linsenflanschschraube / lens head screw		<b>M6 x 12</b> <b>8,0Nm</b> 	7381A2	7381A2	1
3	Linsenflanschschraube / lens head screw		<b>M5 x 30</b> <b>5,5Nm</b>	7381A2	7381A2	2
4	Halter / bracket					1
5	Hülse / sleeve		D 12,0 - d 6,0 - h 4,0mm			2
6	Moosgummi / foam rubber					10cm
7	Lackschutzfolie / paint protection film					20cm





**01** **MARKIERTE FLÄCHE GRÜNDLICH REINIGEN UND LACKSCHUTZFOLIE AUFKLEBEN.**

Thoroughly clean the marked area and stick on the paint protection film.  
 Nettoyez soigneusement la zone marquée et collez le film de protection de la peinture.



**02** **MARKIERTE FLÄCHE GRÜNDLICH REINIGEN UND MOOSGUMMI AUFKLEBEN. SCHRAUBEN ENTFERNEN.**

Thoroughly clean the marked area and stick on the foam rubber. Remove screws.  
 Nettoyez soigneusement la zone marquée et collez le caoutchouc mousse.



**03** **ANLIEGENDE FLÄCHE GRÜNDLICH REINIGEN UND MOOSGUMMI AUFKLEBEN.**

Thoroughly clean the contact surface and stick on foam rubber.  
 Nettoyer soigneusement la surface adjacente et coller sur du caoutchouc mousse.

