

ABDECKUNG EINSPRITZANLAGE

Injection cover | Para sistema de inyección | Couvercle de pompe à injection | Coperchio pompa a iniezione

Artikel.-Nr. 26782-102

RECHTE SEITE
right side
partie droite

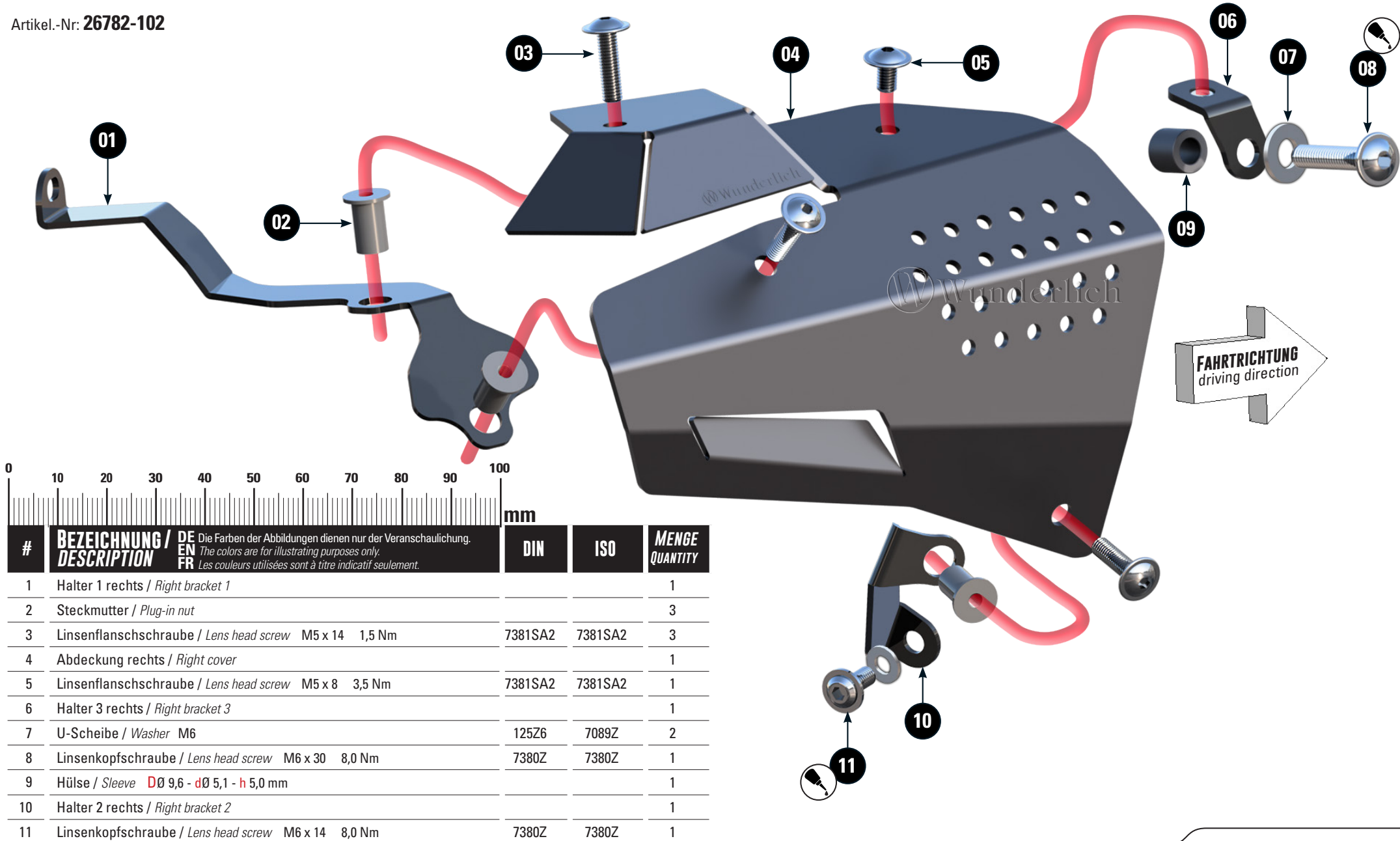

#	BEZEICHNUNG / DESCRIPTION	DE Die Farben der Abbildungen dienen nur der Veranschaulichung. EN The colors are for illustrating purposes only. FR Les couleurs utilisées sont à titre indicatif seulement.	DIN	ISO	MENGE QUANTITY
1	Halter 1 rechts / Right bracket 1				1
2	Steckmutter / Plug-in nut				3
3	Linsenflanschschraube / Lens head screw	M5 x 14 1,5 Nm	7381SA2	7381SA2	3
4	Abdeckung rechts / Right cover				1
5	Linsenflanschschraube / Lens head screw	M5 x 8 3,5 Nm	7381SA2	7381SA2	1
6	Halter 3 rechts / Right bracket 3				1
7	U-Scheibe / Washer M6		125Z6	7089Z	2
8	Linsenkopfschraube / Lens head screw	M6 x 30 8,0 Nm	7380Z	7380Z	1
9	Hülse / Sleeve	DØ 9,6 - dØ 5,1 - h 5,0 mm			1
10	Halter 2 rechts / Right bracket 2				1
11	Linsenkopfschraube / Lens head screw	M6 x 14 8,0 Nm	7380Z	7380Z	1

LINKE SEITE
left side
partie gauche

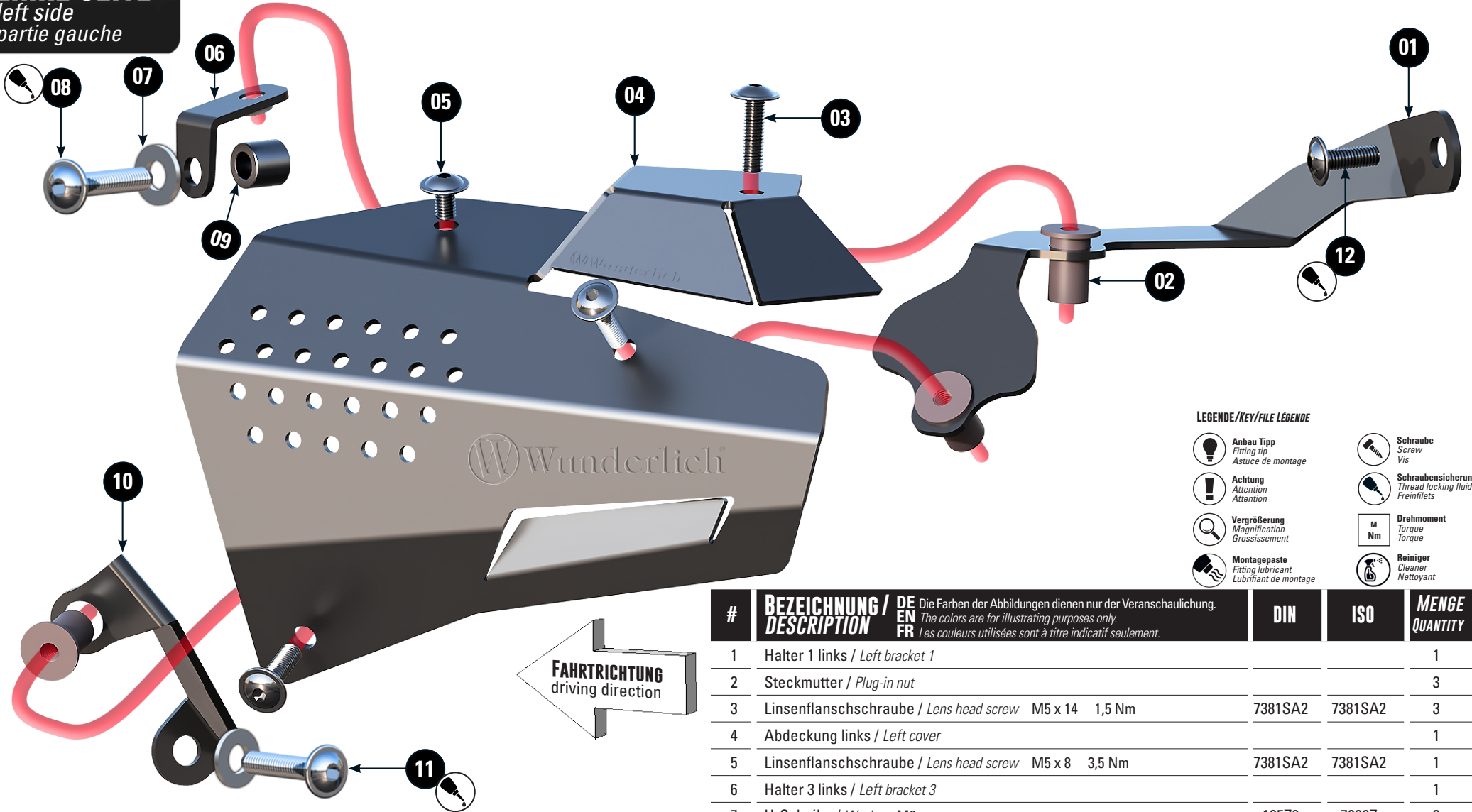

LEGENDE/KEY/FILE LÉGENDE

- Anbau Tipp**
Fitting tip
Astuce de montage
- Achtung**
Attention
Attention
- Vergrößerung**
Magnification
Grossissement
- Montagepaste**
Fitting lubricant
Lubrifiant de montage
- Schraube**
Screw
Vis
- Schraubensicherung**
Thread locking fluid
Freinfillets
- Drehmoment**
Torque
Torque
- Reiniger**
Cleaner
Nettoyant

#	BEZEICHNUNG / DESCRIPTION	DE EN FR	Die Farben der Abbildungen dienen nur der Veranschaulichung. The colors are for illustrating purposes only. Les couleurs utilisées sont à titre indicatif seulement.	DIN	ISO	MENGE QUANTITY
1	Halter 1 links / Left bracket 1					1
2	Steckmutter / Plug-in nut					3
3	Linsenflanschschraube / Lens head screw	M5 x 14	1,5 Nm	7381SA2	7381SA2	3
4	Abdeckung links / Left cover					1
5	Linsenflanschschraube / Lens head screw	M5 x 8	3,5 Nm	7381SA2	7381SA2	1
6	Halter 3 links / Left bracket 3					1
7	U-Scheibe / Washer	M6		125Z6	7089Z	2
8	Linsenkopfschraube / Lenshead screw	M6 x 30	8,0 Nm	7380Z	7380Z	1
9	Hülse / Sleeve	DØ 9,6 - dØ 5,1 - h 5,0 mm				1
10	Halter 2 links / Left bracket 2					1
11	Linsenkopfschraube / Lens head screw	M6 x 14	8,0 Nm	7380Z	7380Z	1
12	Linsenflanschschraube / Lens head screw	M5 x 14	3,5 Nm	7381SA2	7381SA2	1

01

RECHTE SEITE

right side
partie droite

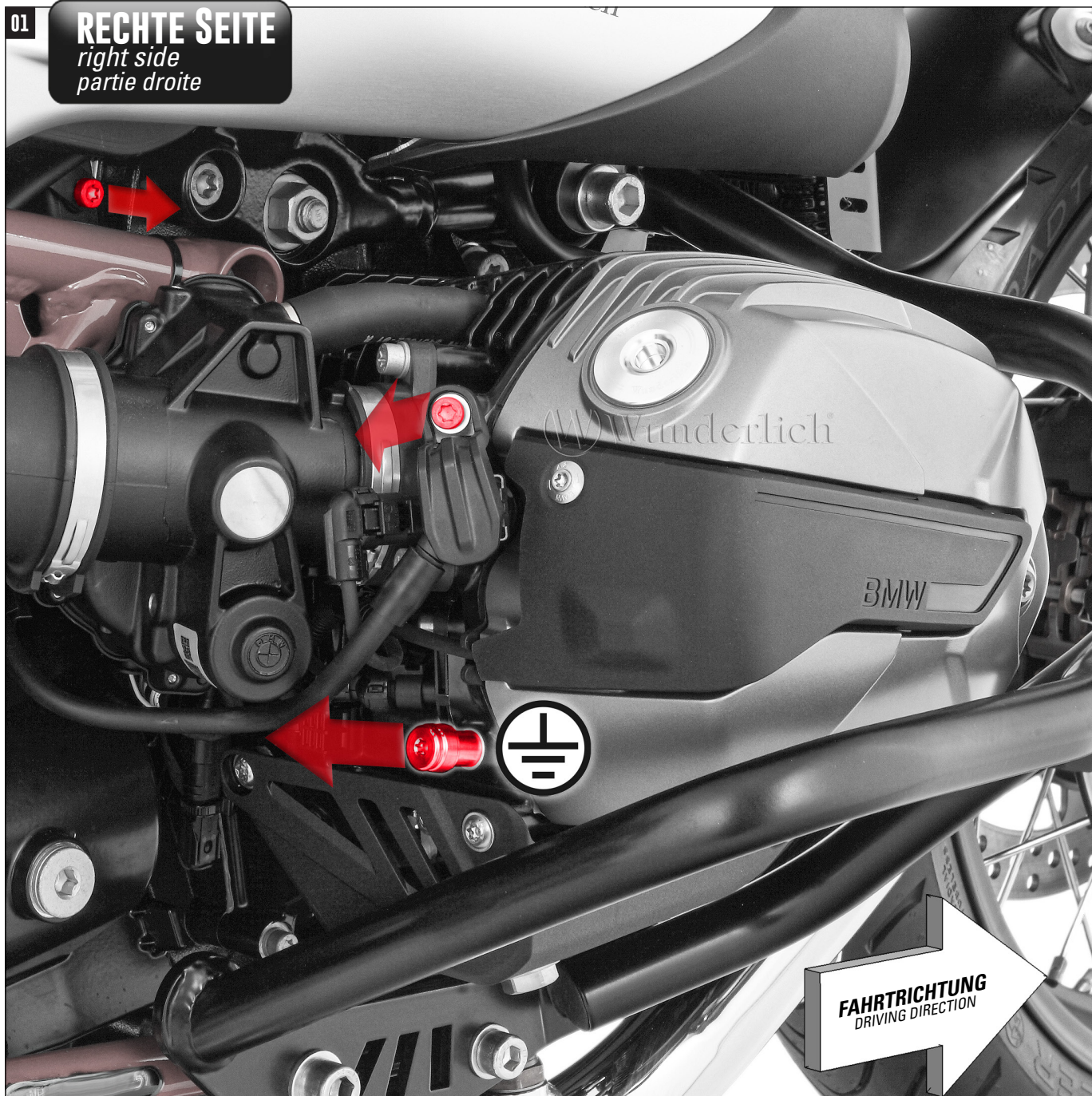

02

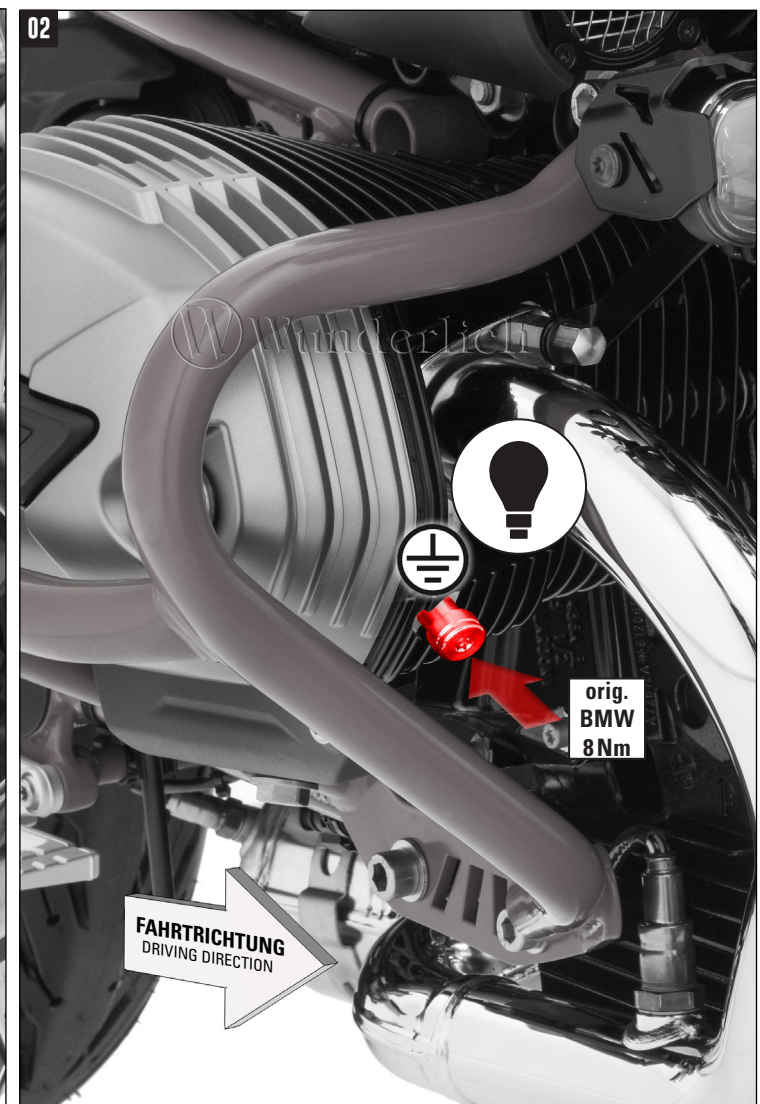

MASSE SCHRAUBE IN FREIE BOHRUNG SCHRAUBEN.
Screw the negative pole into the free bore.
Vissez le pôle négatif dans l'alésage libre.

03

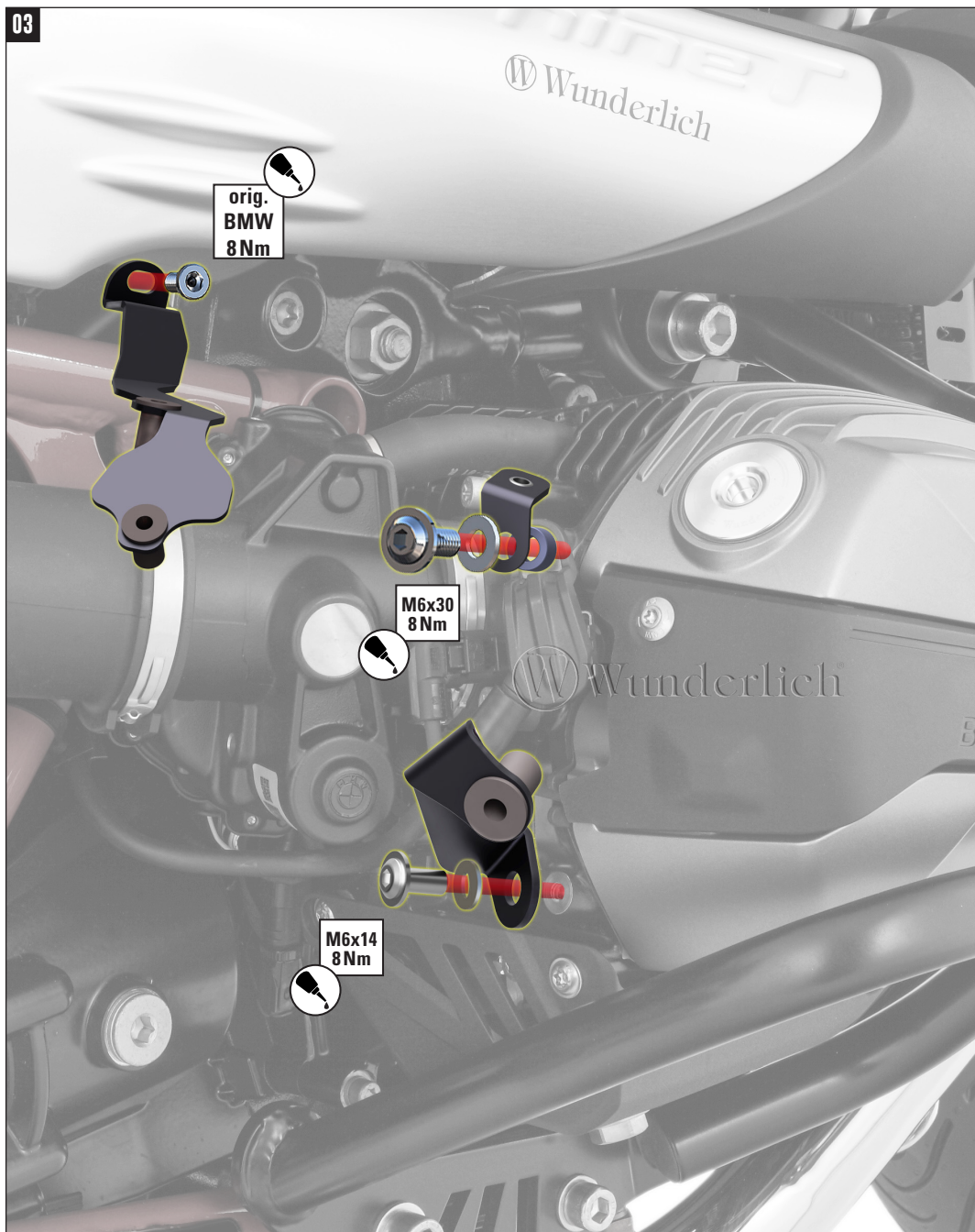

04

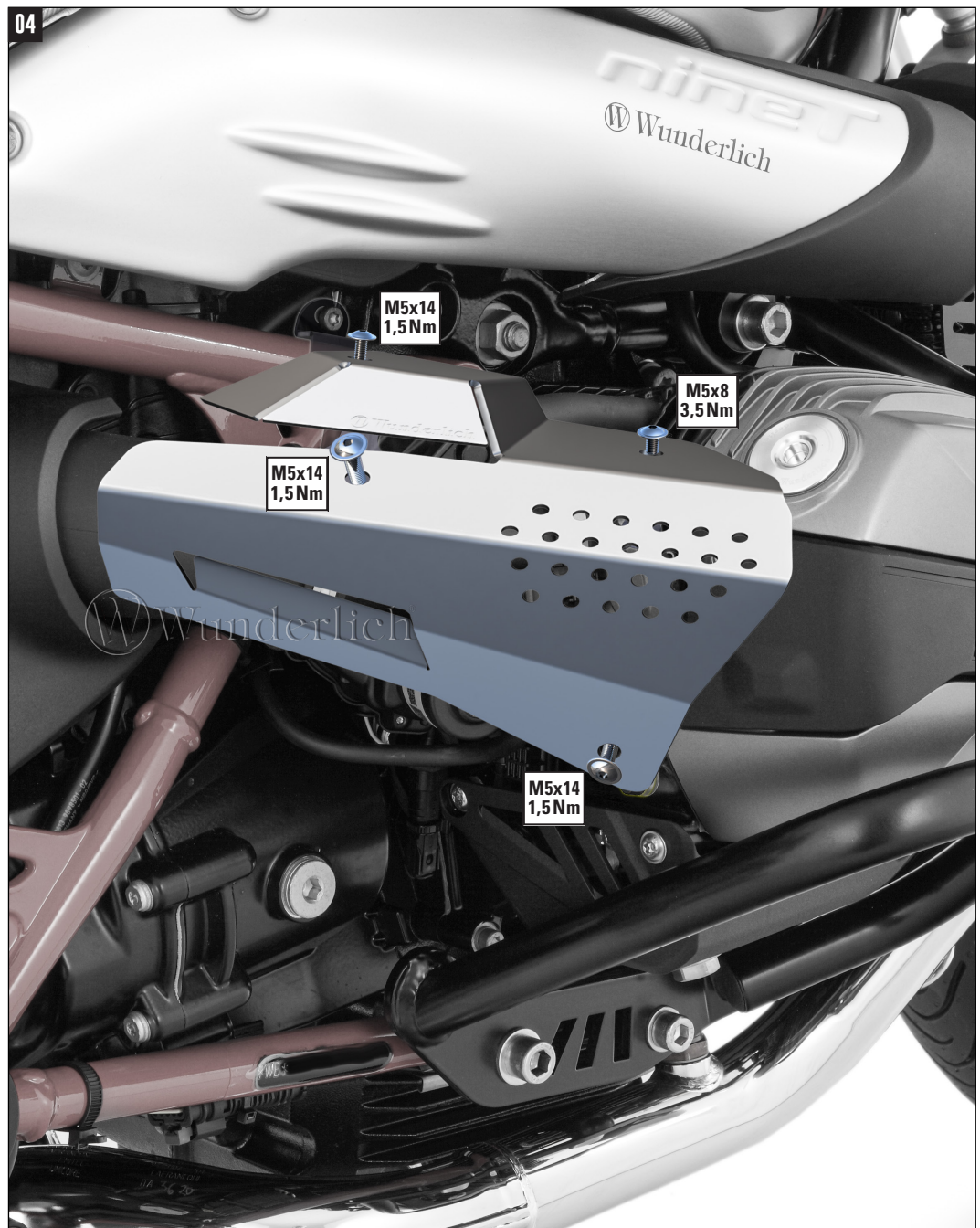

05

LINKE SEITE
left side
partie gauche

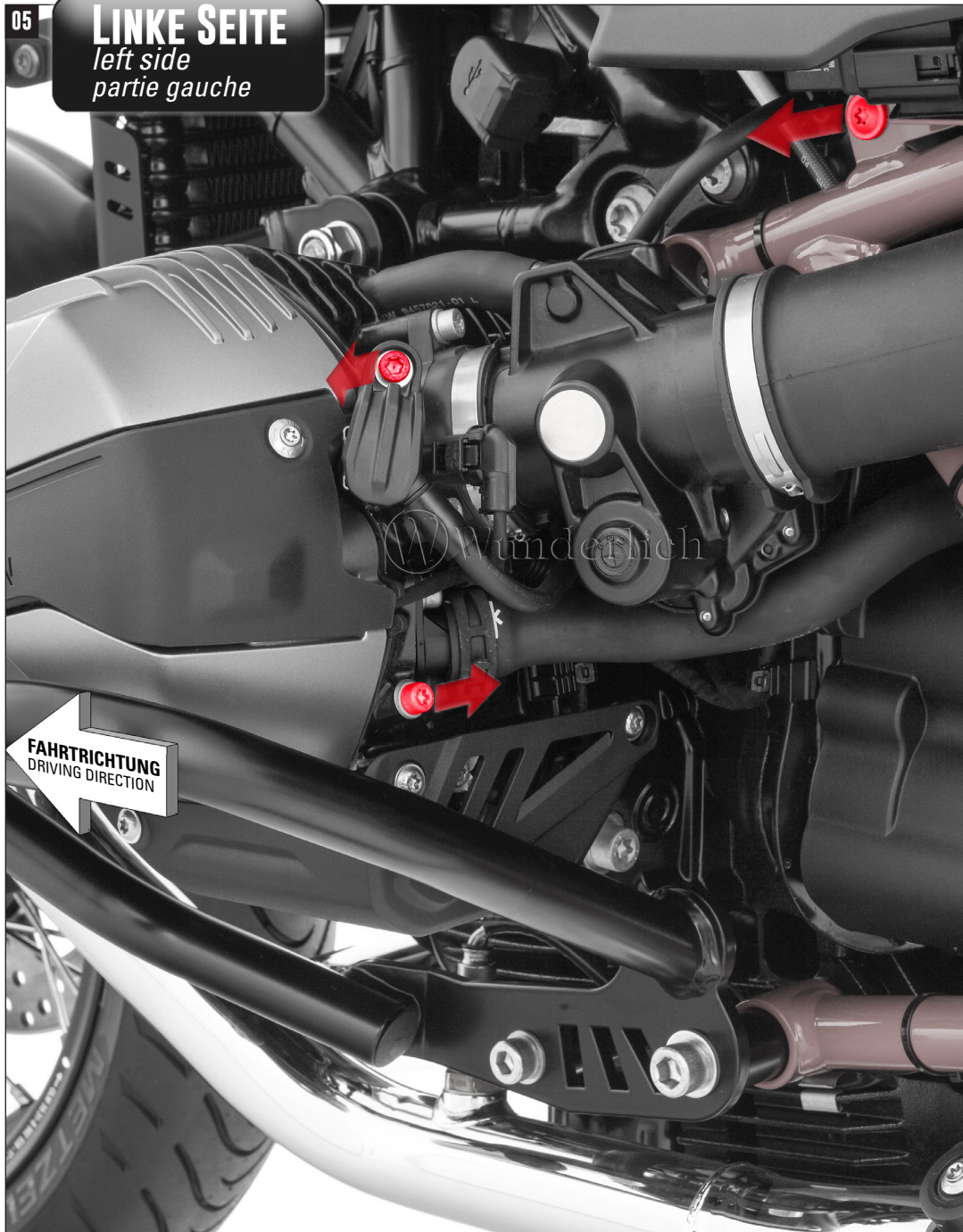

06

