

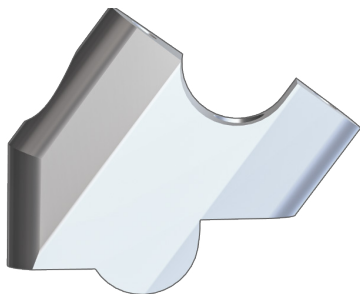







LENKERERHÖHUNG

Handlebar risers | Rehausse de guidon | Alzas maniollar | Riser manubrio

Art.-Nr: 71300-001



LEGENDE / Key / file Légende

-  **Anbau Tipp**
Fitting tip
Astuce de montage
-  **Achtung**
Attention
Attention
-  **Vergrößerung**
Magnification
Grossissement
-  **Montagepaste**
Fitting lubricant
Lubrifiant de montage
-  **Schraube**
Screw
Vis
-  **Schraubensicherung**
Thread locking fluid
Freinfiets
-  **Drehmoment**
Torque
Torque
-  **Reiniger**
Cleaner
Nettoyant

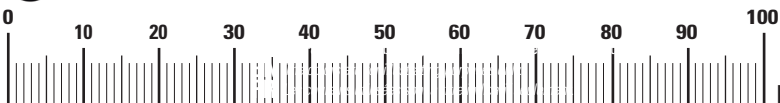

#	BEZEICHNUNG / DESCRIPTION	DIN	ISO	MENGE QUANTITY	
1	Lenkererhöhung (links) / handlebar riser (left side)			1	
2	Lenkererhöhung (rechts) / handlebar riser (right side)			1	
3	Zylinderkopfschraube / cylinder head screw	M8x35 10.9	25Nm	9612ZNNI 14580	2
4	Zylinderkopfschraube / cylinder head screw	M8x30 10.9	25Nm	9612ZNN 14580	2
5	Schraubensicherung / thread locking fluid				1

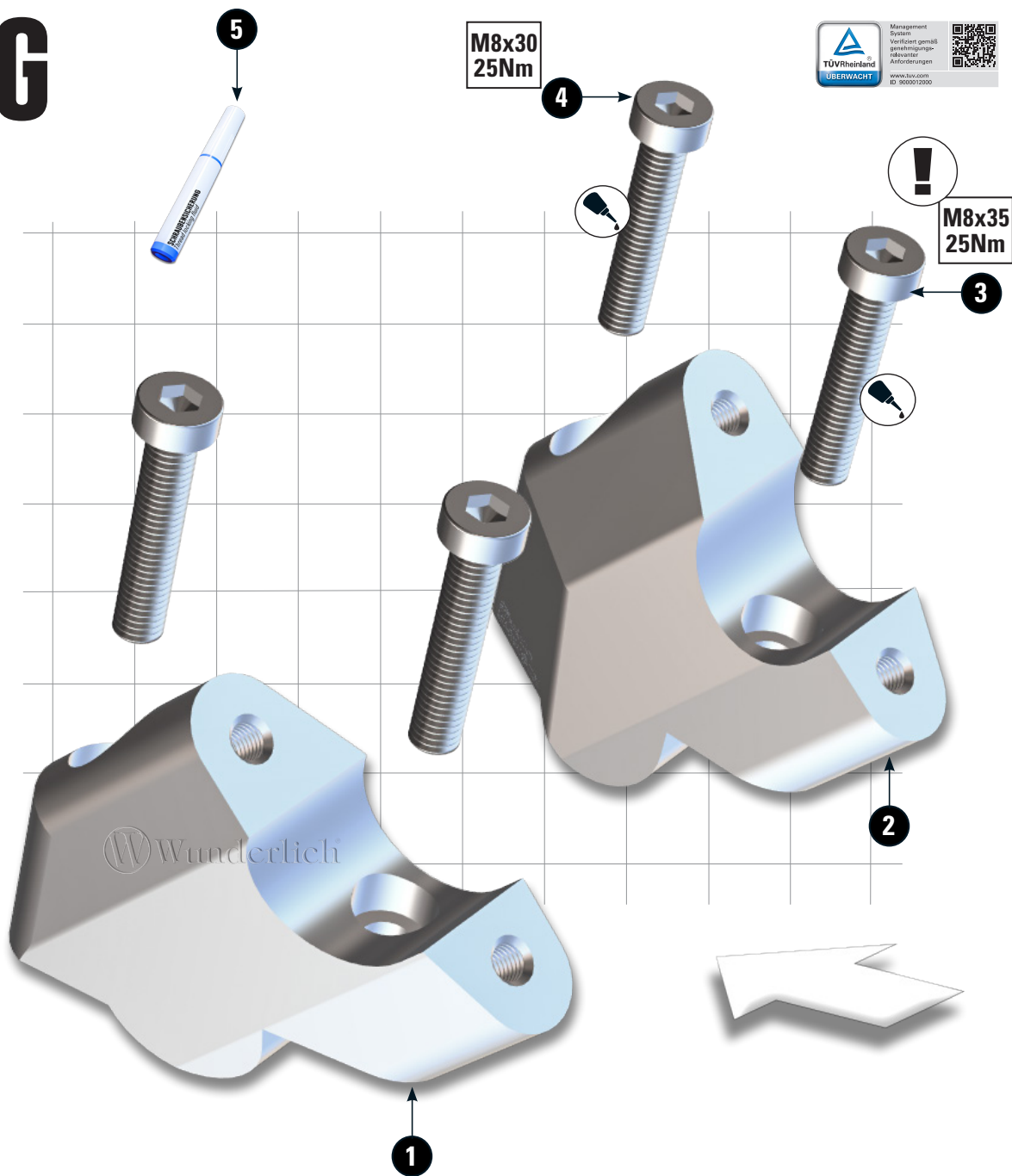

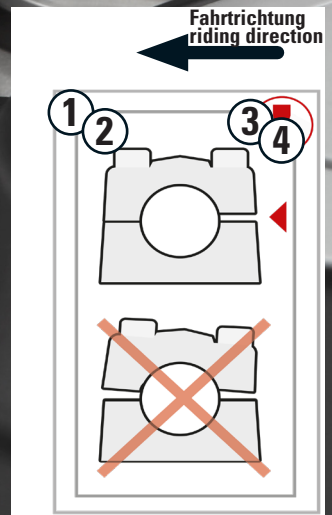

Die Schrauben der Reihe nach wie in Bild 1 dargestellt anziehen.
 Tighten the screws one after the other as shown in picture 1.
 Serrez les vis l'une après l'autre comme indiqué sur l'image 1.