









SCHEIBENVERSTÄRKUNG

Windshield stabilizer | Stabilizzator per Parabrezza | Stabilisateur de Pare-brise | Estabilizador de Parabrisas

Art. Nr.: 90157-002

LEGENDE/KEY/FILE LÉGENDE

-  **Anbau Tipp**
Fitting tip
Astuce de montage
-  **Achtung**
Attention
Attention
-  **Vergrößerung**
Magnification
Grossissement
-  **Montagepaste**
Fitting lubricant
Lubrifiant de montage
-  **Schraube**
Screw
Vis
-  **Schraubensicherung**
Thread locking fluid
Freintilts
-  **Drehmoment**
Torque
Torque
-  **Reiniger**
Cleaner
Nettoyant

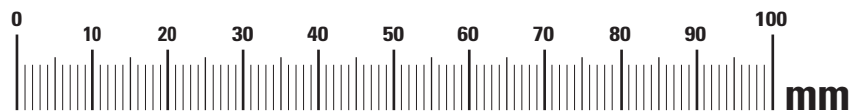

#	BEZEICHNUNG / DESCRIPTION	DE EN	FR	DIN	ISO	MENGE QUANTITY
1	Basishalter / base bracketed					1
2	Scheibehalter / windshield bracketed					1
3	Welle Scheibenverstellung / windshield adjustment shaft					1
4	Bolzen / pin					1
5	Sicherungsscheibe / lock washer			6799		1
6	Sechskantmutter / hexagon nut M6			985	10511	1
7	Rändelschraube / knurled screw M6					1
8	Linsenflanschschraube / lens head screw M5x20			7381	7381	1
9	Hülse / sleeve D=8,5 d=5,5 3mm (M5)					1
10	U-Scheibe / washer M5			9021	7093	1
11	Sechskantmutter / hexagon nut M5			985	10511	1
12	Linsenflanschschraube / lens head screw M6x25			7381	7381	2
13	Hülse / sleeve D=12 d=6,2 3mm (M6)					2
14	Bordsteckdose / socket (Optional)					1
15	Hülse / sleeve 20mm					1
16	Schraubensicherung / Thread locking fluid					1

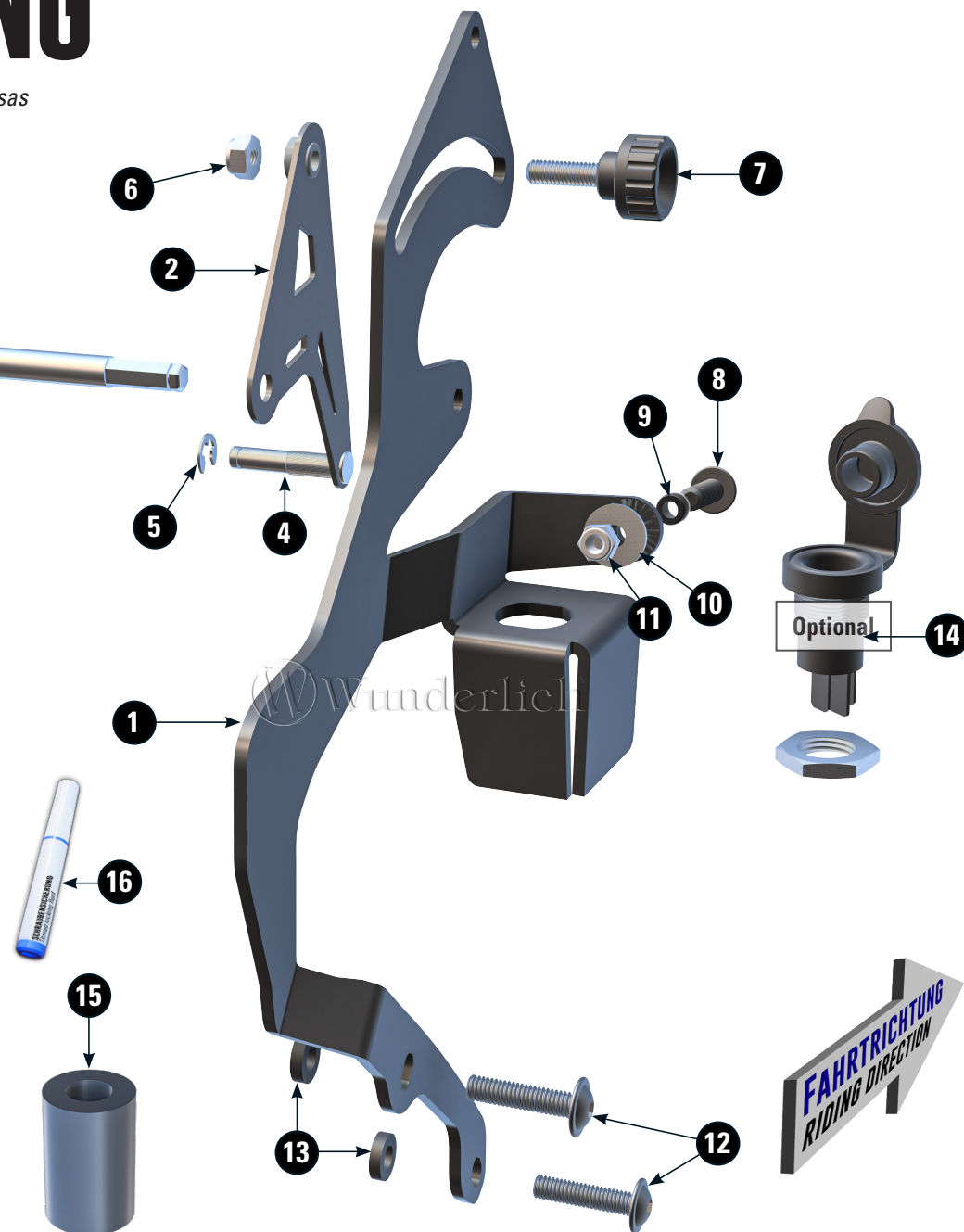

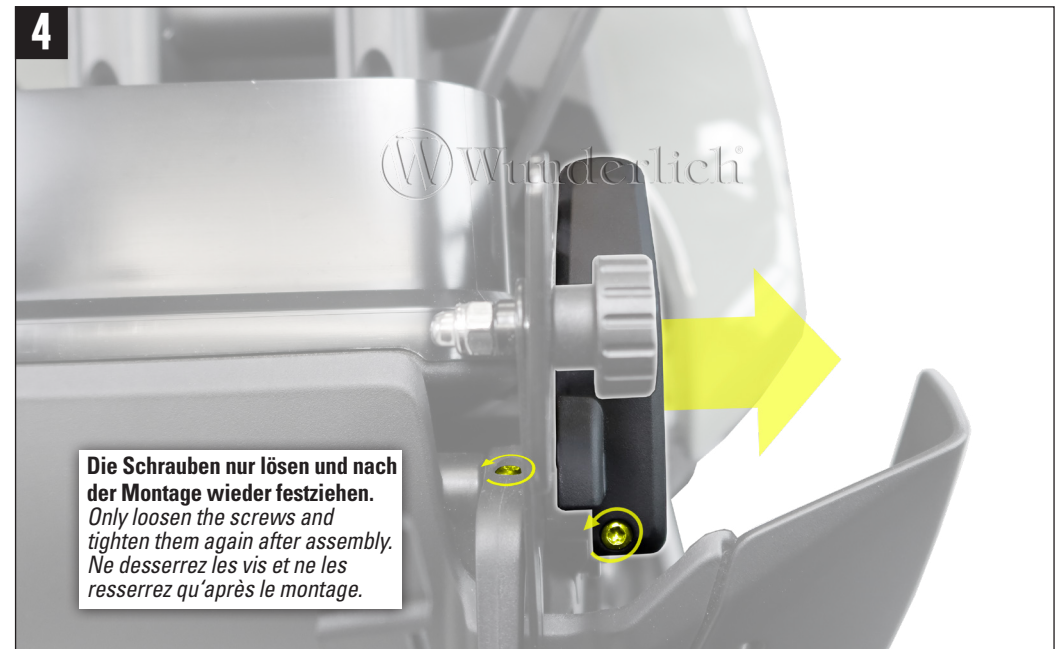
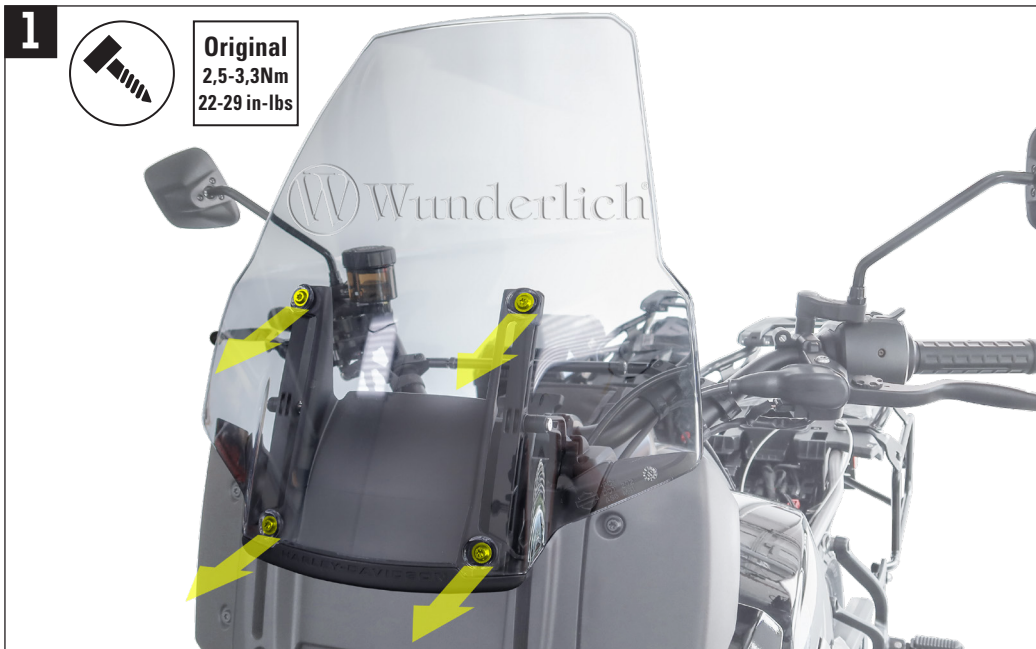

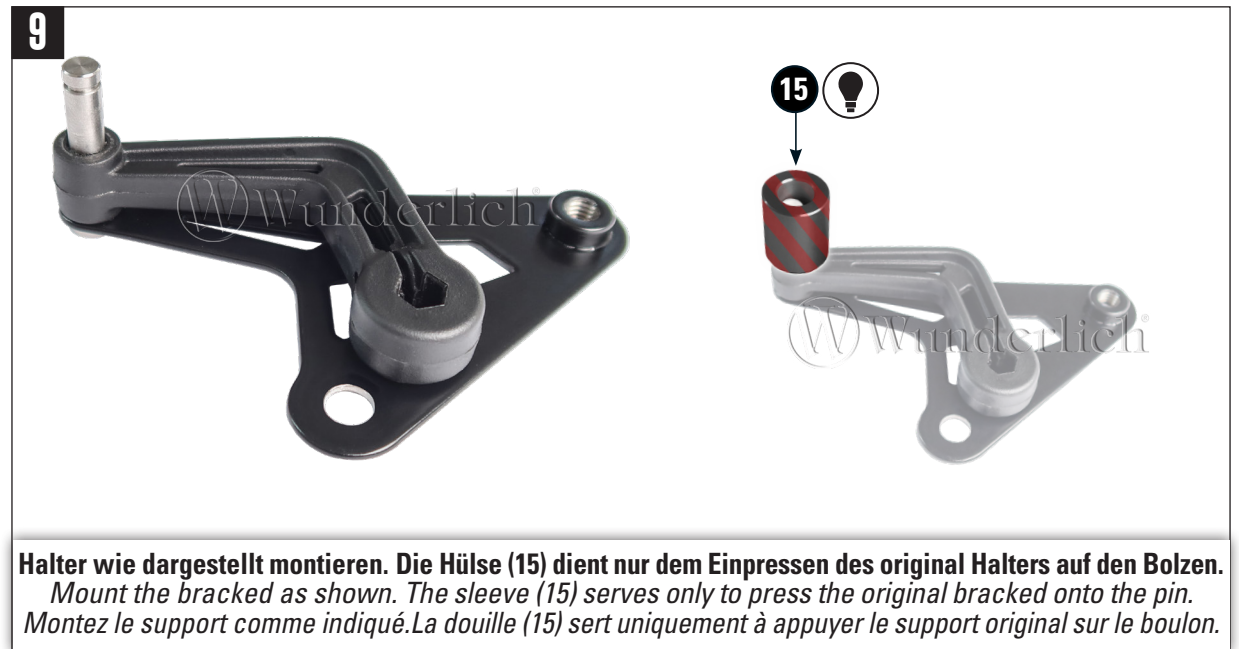

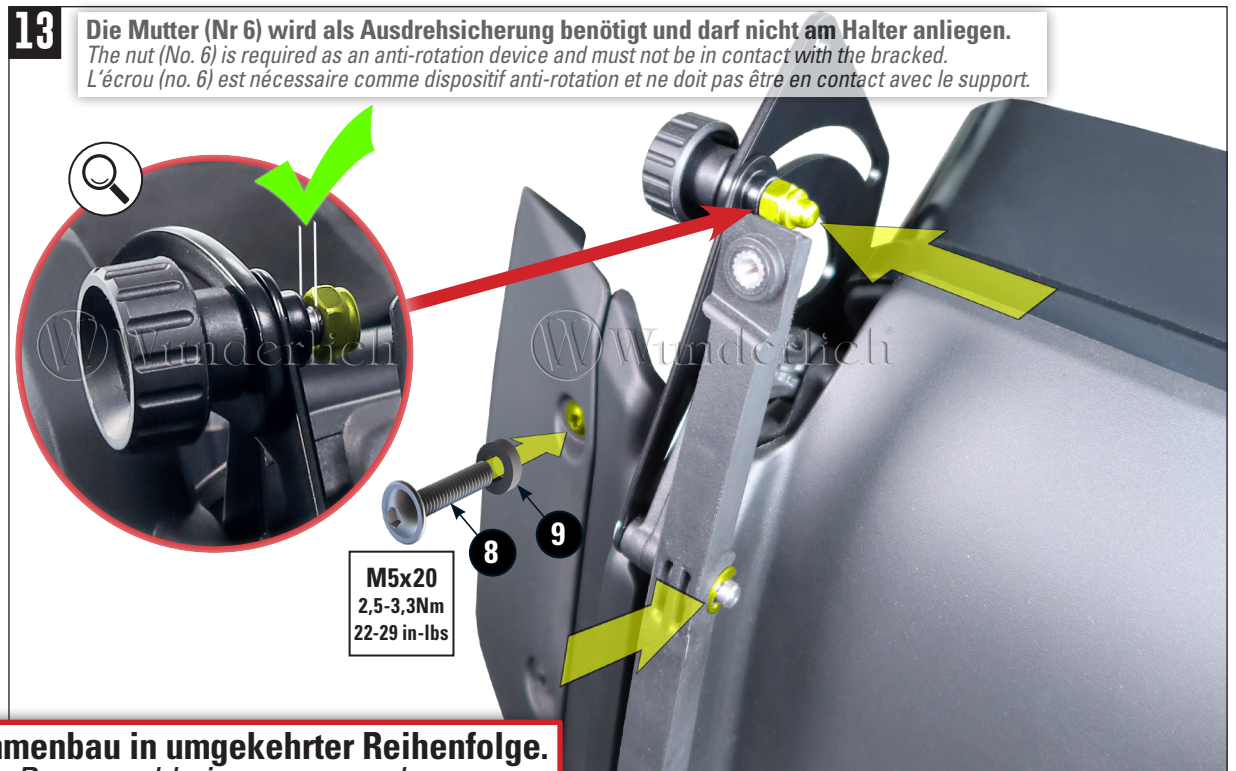
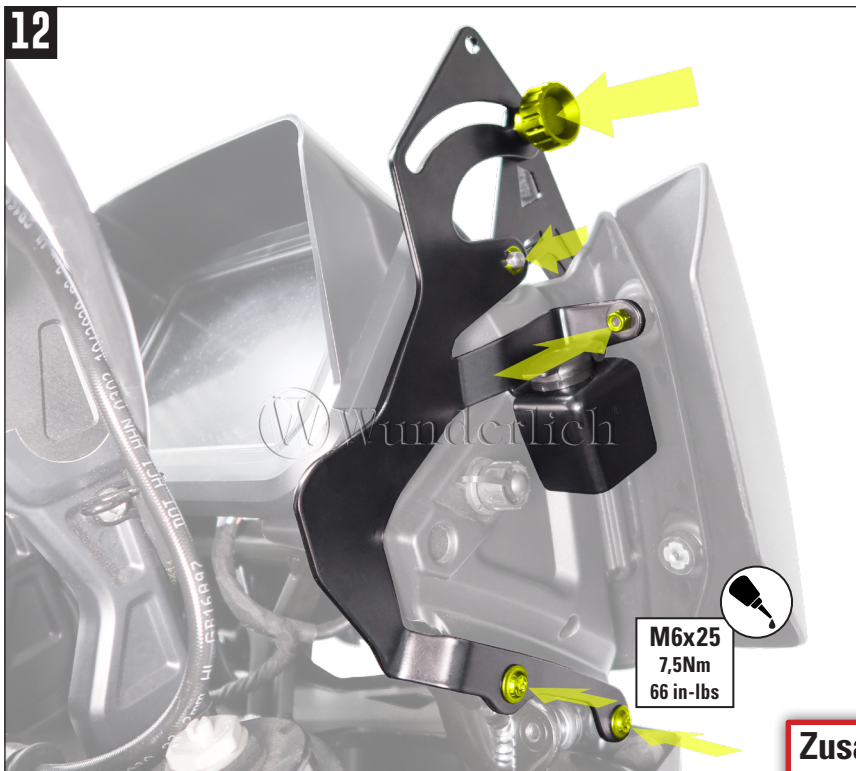
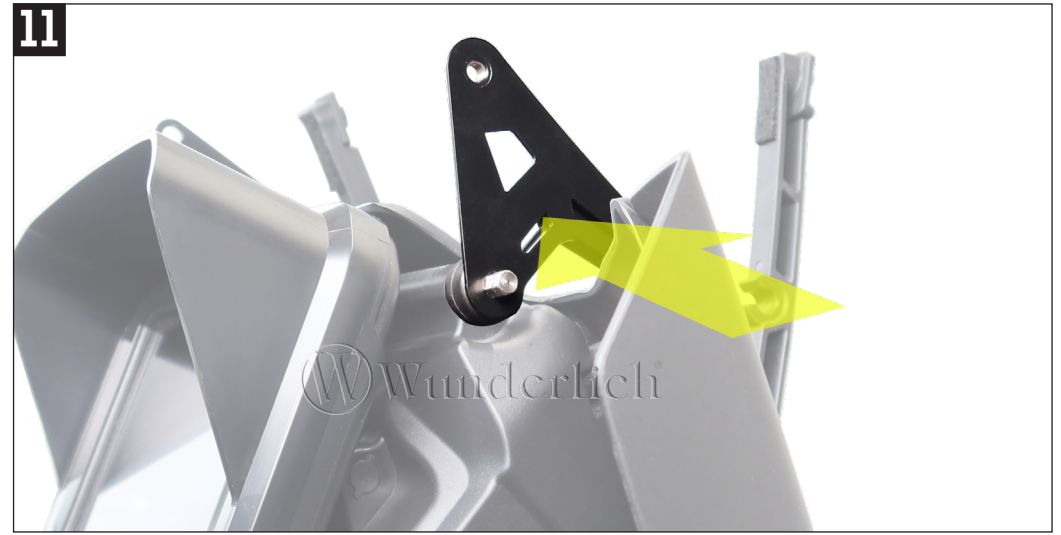

Zusammenbau in umgekehrter Reihenfolge.
Reassemble in reverse order.
Remontez dans l'ordre inverse.